

Product Manual

Catalog

FM-1400(1U system).....	3
FM-2800 (2U system).....	6
FM-5180 (5U system).....	9
OTDT: single-board for 100G coherent transmission service.....	12
100G-OEO-1CHQSFP28: 100G service board.....	13
OTDQ: 100G transponder OEO card.....	15
OTMQ: 4x10G/4x25G OTN Card.....	16
10G-OEO-4CHSFP: 4x10G Any service access board.....	18
2.5G-OEO-4CHSFP: 4x2.5G any service access board.....	19
SOA: 100G semiconductor optical amplifier board.....	21
EDFA: erbium-doped fiber amplifier board.....	22
OLP: optical line protection board.....	23
MDU: multiplexer/de-multiplexer board.....	25
DCF: dispersion compensation board.....	26
OPNC: network management board.....	28
NMS: network management system.....	29
Applications of WDM in single fiber bidirectional transmission.....	32
Applications of WDM transmission networks for disaster tolerance backup.....	33
Applications of OTN transmission bandwidth cloud.....	35
Applications of WDM unidirectional transmission network.....	36
Applications of optical amplification.....	37
OLP line protection applications.....	38
Single fiber unidirectional passive WDM board.....	40
Dual fiber bidirectional passive WDM board.....	41
Single fiber bidirectional passive WDM board.....	43
Add-drop multiplexing passive WDM board.....	44

With the rapid development of industry's informatization, the demand in long distance and large capacity broadband has increased rapidly, resulting in the rapid growth in the traffic of the access layer, metropolitan area layer and backbone network. The dependence on the broadband rent or optical fiber direct-connection can no longer meet the need of industrial clients. Therefore, based on the existing service requirements, the optical transmission network system is designed to meet the demand of future network development, which creatively expands the WDM technology from the backbone network to the metropolitan area and access layer. It provides a reliable, flexible and efficient high broadband carrying solution for the operators, Broadcast and TV, IDC, finance, government, cloud service, massive data and other industries.

FM-1400 (1U System)

The integrated C/DWDM platform of the optical transmission network system FM-1400 is mainly used in the metropolitan area access layer network. It can complete the functions such as optical fiber saving, service multiplexing and distance extension. It can also solve the shortage of fiber resources in the access layer network and provide clients a good solution of broadband multiple service access with low cost and high efficiency. FM-1400 can cooperate with other OTNS series products and build networks according to different requirements.

System Structure



FM-1400

Product Features

- ❖ The standard 1U rack type design fully adopts the way of outlet on the front panel, provides 3 service single-board slots, 1 network management single-board integrated with service slot, 1 fan single-board slot and 2 power single-board slots, which are all pluggable.
- ❖ It supports the WDM for all types of service with the rate of 100Mbit/s~10Gbit/s, and meet the requirements of multiple service access.
- ❖ It supports CWDM and DWDM, and its boards are available for both coarse wavelength and dense wavelength.
- ❖ It supports the access of up to 16 bidirectional 10G services or 32 unidirectional 10G services on single equipment, and the expansion of transmission capacity is available through the equipment stack.
- ❖ It supports a transmission distance of 120 km for 2.5G, a transmission distance of 80 km for 10G. And longer-distance transmission can be achieved by configuring the optical amplifier or dispersion compensation unit.
- ❖ It supports application scenes of single fiber unidirectional transmission, single fiber bidirectional transmission and double fiber bidirectional transmission.
- ❖ It supports a unified network management platform and provides a perfect performance monitoring ability in network and equipment.
- ❖ It supports the power supply of 220V AC or -48V DC, with 1+1 power input protection.
- ❖ It supports deployment in various locations such as cabinets, outdoor cabinets, desktops, hanging walls and holding poles.
- ❖ It supports installation of free configuration and it is the plug-and-play type.
- ❖ It adopts the green energy-saving design with power consumption of 60W in typical configuration.

Product Specifications

Performance Parameters	Technical Indicators
Product Model	FM-1400
Equipment Size	1U:44 mm (height)x442 mm (width)x220 mm (depth)
Service Slot	4 slots (the network management board is optional for one of the slots)
Transmission Capacity of Single Equipment	16 * 10G bidirectional transmission 32 * 10G unidirectional transmission
Wavelength	CWDM:1270nm~1610nm DWDM:C Band, 100 GHZ or 50 GHZ
Maximum Rate of Single Channel	10Gbit/ s
Transmission Distance	80km (without optical amplification)
Service Interface Type	100M~10G all kind of services, including services of STM-1/4/16/64, OC-3/12/48/192, FE, GE, 10GE, FC100/200/400/800/1200, FICON, ESCON, EPON, GPON, CPRI 1/2/3/6/7
Clock Features	Support IEEE 1588 V2
Optical Transceivers	SFP/SFP +, LC type interface
Network Topology	Point to point, chain type, star type, ring type
Installation	"19"and 23" cabinets, ETSI 300mm/600mm cabinets Wireless outdoor base station cabinet, FTTX outdoor cabinet, hanging wall, holding pole.
Working Temperature Range	- 10 °C~60 °C (typical)
Working Humidity Range	5~95% without condensation
Storage Temperature Range	-40°C ~85°C
Heat Dissipation	Fan cooling
Power Supply Mode	AC: 90~260 V or DC: -36~-72 V (support 1+1 backup power input)
Power Consumption	60W (typical)

FM-2800 (2U System)

The integrated C/DWDM platform of optical transmission network system FM-2800 is mainly used in metropolitan area nodes. It solves the shortage of fiber resources below the metropolitan area network and completes the unified carry of multiple services for operators, broadcast and TV system, IDC, finance, government, cloud and big data, and realizes network flattening. It effectively reduces the network construction cost and operation cost and provides the best solution for the metropolitan area transmission scenes. FM-2800 can work with the other OTNS series products and build networks according to different requirements.

System Structure



FM-2800

Product Features

- ❖ The standard 2U chassis rack design fully adopts the way of wire connection on the front panel. It provides 7 service board slots, 1 network management board slot (which can also be used a service slot), 1 fan board slot and 2 power board slots, which are all pluggable.
- ❖ It supports multiple services of STM-1/4/16/64 and services such as FE, GE, 10GE, 40GE, 100G, SAN, CPRI and PON and meets the needs of multi-service access.
- ❖ It supports the access of up to 32 bidirectional 10G services or 64 unidirectional

10G services on single equipment, and the expansion of transmission capacity to 960 Gbit/s is available by adding more equipment.

- ❖ It supports application scenes of single fiber unidirectional, single fiber bidirectional and double fiber bidirectional transmission.
- ❖ It supports the maximum transmission distance of 130km (36 db) for a single span and can realize long distance transmission through the relay.
- ❖ It supports various network protection solutions such as optical layer 1+1 channel protection or optical line side 1+1 protection, and provides multiple protection for vital equipment units and optical fiber lines with a high reliability
- ❖ It supports the power supply of 220V AC or -48V DC with a 1+1 power input protection
- ❖ It supports 19 inches and ETSI cabinet and is easy to deploy with good applicability.
- ❖ It supports installation of free configuration, and it is the plug-and-play type.
- ❖ It supports the unified network management platform and provides a perfect performance monitoring ability for network and equipment.
- ❖ It adopts green energy-saving design with power consumption of 60W typically.
- ❖ It focuses on the metropolitan area network and meets needs of service access & convergence network construction.

Product Specification

Performance Parameters	Technical Indicators
Product Model	FM-2800
Equipment Size	2U: 88 mm (height)x442 mm (width)x220 mm (depth)
Service Slot	8 slots (network board is optional for one of the slots)
Transmission Capacity of Single Equipment	32 channels*10G bidirectional transmission 64 channels*10G unidirectional transmission 4 channels*10G unidirectional and bidirectional transmission
Wavelength	CWDM:1270nm~1610nm DWDM:C Band, 100 GHZ or 50 GHZ
Max rate of Single Channel	100Gbit/ s
Transmission Distance	For DWDM system, it supports the maximum transmission distance of 130km (36 db) for a single span For CWDM system, it supports a maximum transmission distance of 80 km
Optical Amplifier	25 db (nominal gain)
Service Interface Type	STM-1/4/16/64, OC-3/12/48/192, FE, GE, GE, 40 10 GE, GE, FC100 100/200/400/200/400, FICON, ESCON, EPON and GPON, CPRI 1/2/3/6/7, etc
Clock Features	Support the IEEE 1588 V2
Optical Connector	SFP/SFP +, LC type interface
Network Topology	Point to point, chain type, star type, ring type
Installation	"19"and 23" cabinets, ETSI 300mm/600mm cabinets Wireless outdoor base station cabinet, FTTX outdoor cabinet, hanging wall
Work Temperature Range	- 10 °C~60 °C (typical)
Work Humidity Range	5~95% without condensation
Storage Temperature Range	-40°C ~85°C
Heat Dissipation	Fan cooling
Power Supply Mode	AC: 90~260V or DC: -36~-72 V (support 1+1 backup power)
Power Consumption	120W (typical)

FM-5180 (5U System)

The FM-5180 type optical transmission network system, which is mainly used in metro convergence layer and metro core layer, is a new generation of optical transmission system with high integration, huge capacity and long distance. The equipment applies the advanced transmission technology and high integration technology, applicable to the whole IP transmission. It provides the function of wide broadband, high capacity and fully transparent transmission, which can realize smooth capacity upgrade, offer a comprehensive, flexible and mature protection solution. It's a stable platform for multiple service operation and future network upgrade and expansion.

System Structure

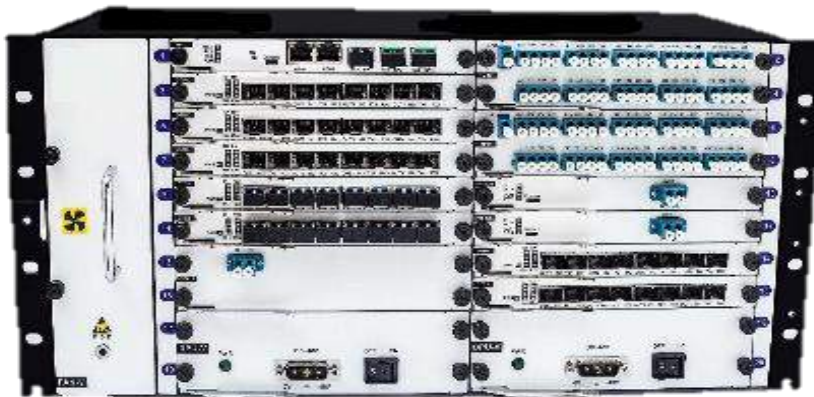

FM-5180

Product Features

- **Huge capacity transmission and capacity of modular upgrade**
- ❖ It supports 96 channels' 10G transmission system at C band
- ❖ It supports access rate of up to 100Gbit/s for single channel
- ❖ It supports a single level multiplexing/de-multiplexing architecture for 80/96 channels, which can realize multiplexing/de-multiplexing for 80 channels without

the need of OCl

- ❖ It supports system expansion from 40/48 to 80/96 channels and also a modular expansion for 10G to 100G, which ensures the low investment in the early stage of the network construction and the smooth expansion in the long run, so as to meet the future growing demand in bandwidth

■ **Multi-rate, multi-protocol, full-service access and convergence**

- ❖ Access to SDH/SONET services, data services of POS, GE, 10 GE, 40 GE, 100 GE and other services of SAN, CPRI at various rate levels.
- ❖ Powerful capacity of service convergence, support 8xFE service convergence, 8×GE service convergence and 10×10GE service convergence

■ **High integration, green and easy maintenance**

- ❖ 5U frame chassis supports 18 service slots, with a super high level of integration
- ❖ Compact structure and flexible installation, available for installation in cabinet with 300 mm depth
- ❖ It supports free-of-configuration installation, and the equipment is plug-and-play
- ❖ It supports a unified network management platform and provides a perfect performance monitoring ability in performance of network and equipment
- ❖ Lowest power consumption in the industry, assist operators to build green and energy-saving network

■ **Outstanding architecture design and secure data transmission**

- ❖ It offers a variety of network level protection and provides comprehensive protection for optical fiber line and service
- ❖ It provides comprehensive equipment protection: power equipment protection, fan protection
- ❖ All-service transparent transmission reduces the transmission delay of circuit cross and ensures the reliability of transmission
- ❖ All optical interfaces are pluggable and reusable, which reduces the investment of spare parts

Product Specification

Performance Parameters		Technical indicators
Product Model		FM-5180
Equipment Size		5U: 220 mm (height)x442 mm (width)x220 mm (depth)
Service Slot		<ul style="list-style-type: none"> ● 16 slots for DC power equipment (network card is optional for one of the slots) ● 16 slots for AC power equipment (network card is optional for one of the slots)
Maximum Channel Number		DWDM: 96 channels; CWDM: 16 channels
Wavelength		<ul style="list-style-type: none"> ● DWDM: C- Band, 100GHz or 50GHz ● CWDM: 1270nm~1610nm
Max Transmission Rate of Single Channel		100Gbit/s
Service Type Supported		STM-1/4/16/64/256、OC-3/12/48/192/768 any service of 100M~2.5Gbps FE/GE/10GE/40GE/100GE ESCON/FICON/FICON Express、 FC100/FC200/FC400/FC800/FC1200/SAN EPON、GPON、CPRI 1/2/3/6/7
Clock Features		Support IEEE 1588 V2
Line Rate		2.5Gbit/s, 10Gbit/s, 100Gbit/s
Network Topology		Point to point, chain, star, ring, ring-with-chain, ring-cross, and ring-tangency type
Backup and Protection	Network Level Protection	Client-side 1+1protection, 1+1 protection inside board, optical multiplex section 1+1 protection, optical line 1+1 protection
	Equipment Level Protection	<ul style="list-style-type: none"> ● Power supply backup ● Fan backup
Installation		"19"and 23" cabinets, ETSI 300mm/600mm cabinets
Work Temperature Range		- 10 °C~60 °C (typical)
Work Humidity Range		5~95% without condensation
Storage Temperature Range		-40°C~85°C
Heat Dissipation		Fan cooling
Power Supply Mode		AC: 90~260V or DC: -36~-72 V (support 1+1 power input backup)
Power Consumption		300W (typical)

OTDT: Single-Board for 100G Coherent Transmission

Service

OTDT is an access single-board for services of 1-channel 100Gbit/s rate. It adopts the key advanced technology such as DP-QPSK modulation formats and coherent reception, overcomes the challenge of the high-speed transmission system in the physical transmission effect on the aspects of OSNR requirements, CD tolerance, PMD tolerance and nonlinear, and it provides the transmission network with a solution of large capacity and large broadband 100G coherent transmission system.

Product Diagram

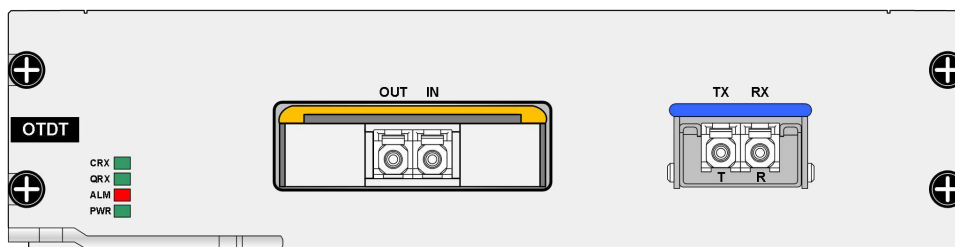

Functional Structure

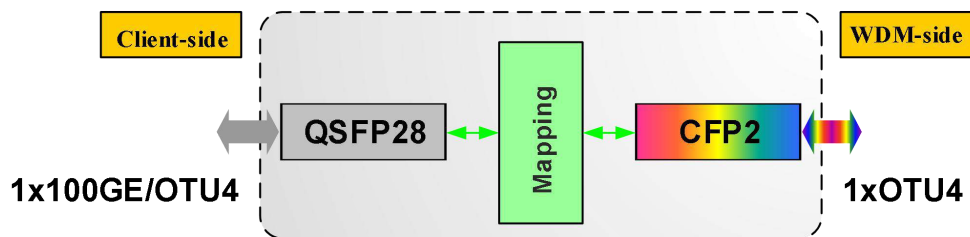

Product Specification

Product Model	OTDT
Basic Function	Support 1-channel 100G transparent transmission and can convert 1-channel 100G service signal into a OTU 4 optical signals of a standard DWDM wavelength
Access Service Type	100G Ethernet or 100G OTN
Occupied Slot Number	Occupy 2 slots, applicable to FM-2800 or FM-5180
WDM Technology	Support DWDM: C Band, 100GHz or 50GHz
3R Technology	Support 3R function: Re-amplifying, Retiming, Re-shaping
Network Management Function	<ul style="list-style-type: none"> ● Support real time monitoring for port working state, including: transmitting optical power, receiving optical power, temperature, etc ● Support port loopback and port shutdown
Client-side Interface	Support 1 pluggable optical port QSFP28, with LC or MPO type interface
WDM-side Interface	Support 1 pluggable optical port CFP2, with LC type interface
Typical Power Consumption	30 w
MTBF	> 100000 hours

100G-OEO-1CHQSFP28: 100G Service Board

100G-OEO-1CHQSFP28 is a single access board for 1-channel 100Gbit/s rate service. Its main function is to complete the operations of OTN framing and SDFEC coding inside the board for the optical signal of 1-channel 100Gbit/s rate services, and then output 1-channel OTU4 optical signal. A 100G coherent transmission CFP optical transceiver or a 4x25G incoherent transmission CFP optical transceiver can be chosen at the WDM side to realize the common application of service board for the 100G coherent or incoherent transmission systems.

Product Diagram

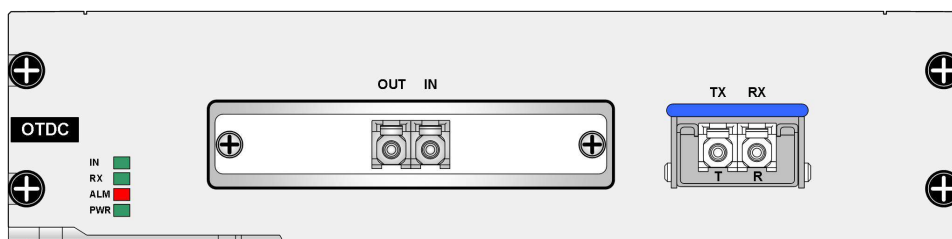

Functional Structure

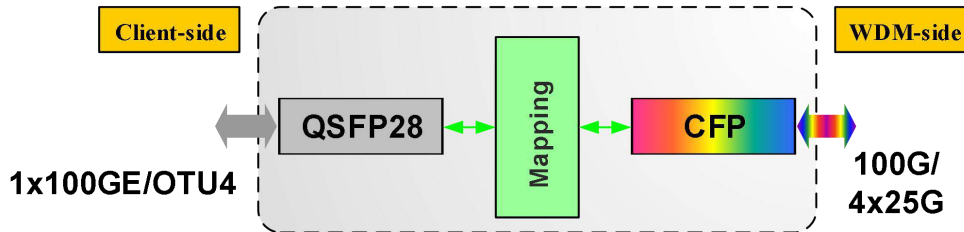

Product specification

Product Model	100G-OEO-1CHQSFP28
Basic Function	Support 1-channel 100G transparent transmission and can convert 1-channel 100G service signal into the OTU4 optical signal of a standard DWDM wavelength or 4 25G-optical-signals at the standard DWDM wavelengths
Access Service Type	100G Ethernet or 100G OTN
Occupied Slot Number	Occupy 2 slots, applicable to FM-2800 or FM-5180
WDM Technology	Support DWDM: C Band, 100GHz or 50GHz
3R Technology	Support 3R function: Re-amplifying, Retiming, Re-shaping
Network Management function	<ul style="list-style-type: none"> ● Support real time monitoring of the port work state, including: transmitting and receiving optical power, temperature, etc ● Support port loopback and port shutdown function
Client-side Interface	Support one pluggable optical port of QSFP28, with LC or MPO interface
WDM-side Interface	Support a 100G port based on CFP (support coherent IPL CFP or 4x25G DWDM CFP), with LC interface
Typical Power Consumption	20W
MTBF	> 100000 hours

OTDQ: 100G Transponder OEO Card

OTDQ is a 4*40Gbit/s or 4*100Gbit/s service signal OEO (photoelectric optical relay) amplifying board .The single board supports the bidirectional convert of 2 channels' 40G or 100G optical signal modes and supports the unidirectional amplification of 4 channels' 40G or 100G optical signals, which is widely used in operators, private networks and information fields.

Product Diagram

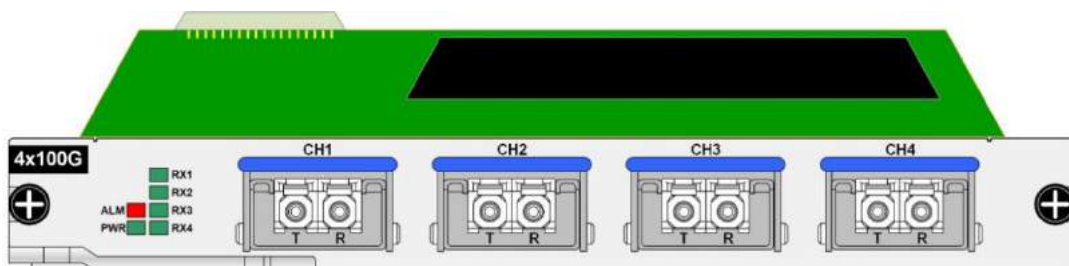

Functional structure

Bidirectional convert of 2 channels' 40G or 100G optical signal modes

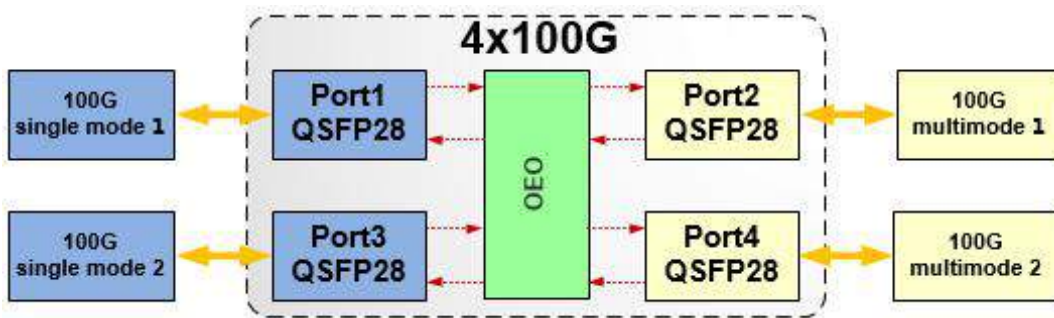

Unidirectional amplification of 4 channels' 40G or 100G optical signal

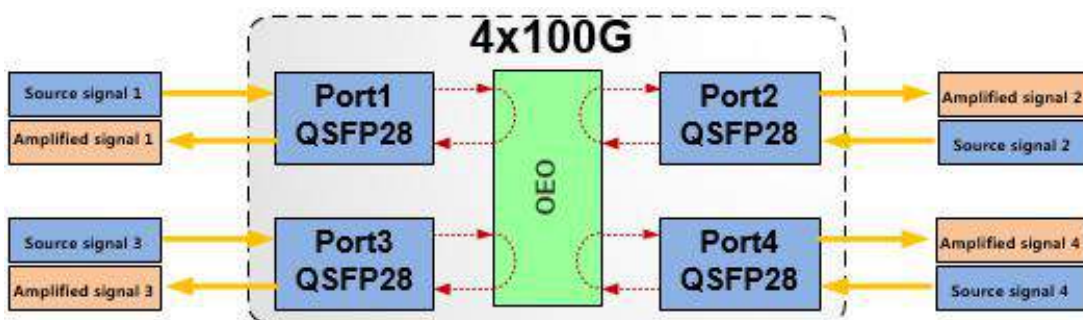

Product Specification

Product Model	OTDQ
Basic Function	Support 4 channels of 40G or 100G service optical signal relay amplification or single and multi-mode conversion of 4 channels of optical signals
Access Service Type	40G or 100G Ethernet
Occupied Slot Number	Occupy 1 slot, applicable to the platform of the whole OTN series
3R Technology	Support 3R function: Re-amplifying, Retiming, Re-shaping
Network Management Function	Support real time monitoring of the port working state, including: transmitting optical power and receiving optical power, temperature, etc. Support port loopback and port shutdown
Optical Interface	Support four pluggable optical port QSFP28 or QSFP28+
Typical Power Consumption	20W
MTBF	> 100000 hours

OTMQ: 4x10G/4x25G OTN Card

OTMQ is a 4x10G/25G service aggregation single card. It uses industry-leading chip technology and can aggregate the 4 channels of 10G any services into one 40G service or 4 channels of 25G any services into one 100G service. The reverse process of the above can also be realized. It's suitable for the application of the optical transmission network of the metro access and metro aggregation.

Product Diagram

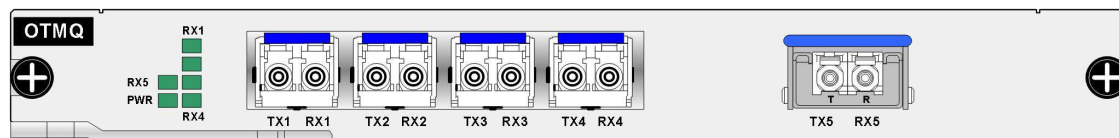

Functional Structure

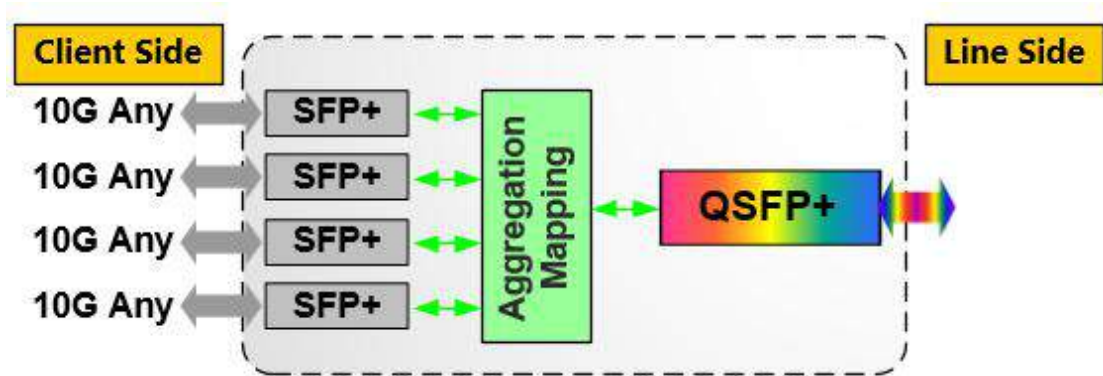
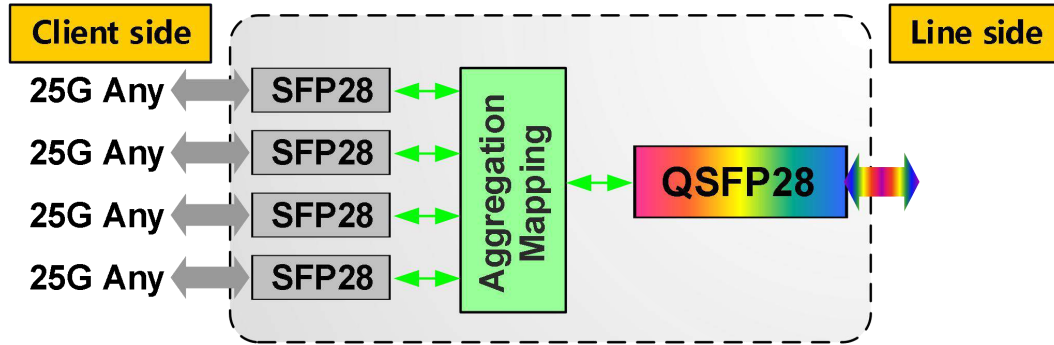

Product Specification

Product Model	OTMQ
Basic function	Support 4-channel 10G/25G service transparent transmission and can aggregate the 4-channel 10G/25G service signals into a 1-channel 40G/100G service signal
Access service type	10GE LAN/WAN, STM-64/OC-192, FC8G, OTU2, OTU2e
Occupied slot number	Occupy 1 slot, applicable to the platform of the OTNs
WDM technology	Support DWDM: C Band, 100GHz or 50GHz
Network management function	Support real time monitoring for port working state at the client side and line side, including: transmitting optical power, receiving optical power, temperature, etc.
Client-side interface	Support 4 pluggable optical ports SFP+/SFP28, with LC type interface(SMF&MMF)
Line-side interface	Support one pluggable optical port QSFP+ or QSFP28

Typical power consumption	15w
MTBF	> 100000 hours

10G-OEO-4CHSFP: 4x10G Any Service Access Board

10G-OEO-4CHSFP is a 4-channel 10G service access card. Its main function is to finish the 3R regeneration of any 4-channel signals under any protocol within the access rate of 1.25 Gbit/s~11.3 Gbit/s, and then convert them into optical signals of the standard DWDM or CWDM wavelength, so that the MUX unit can multiplex the optical signals with different wavelengths and also achieve the reverse process. It's applicable to the wavelength division transmission solution for any access of services with the rate of 10G or below.

Product Diagram

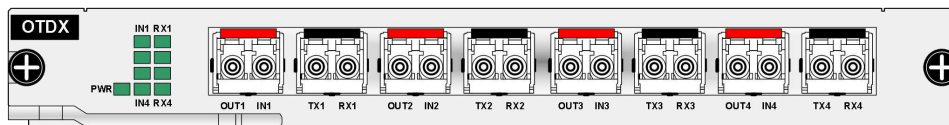

Functional Structure

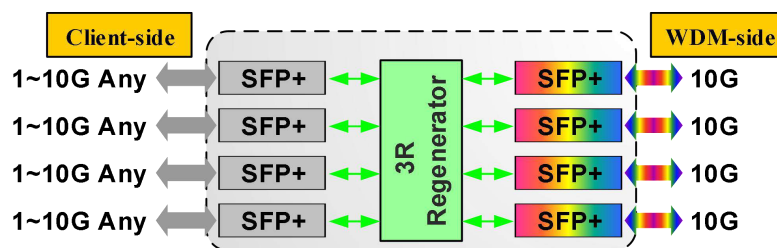

Product Specification

Product Model	10G-OEO-4CHSFP
Basic Function	<ul style="list-style-type: none"> ● It supports bidirectional transmission of 4-channel services with any rate within 1.25 Gbit/s~11.3 Gbit/s ● It supports unidirectional transmission of 8-channel services with any rate within 1.25 Gbit/s~11.3 Gbit/s
Access Service Type	<ul style="list-style-type: none"> ● GE, 10GE, STM-16/64, ● FC 1G/2G/4G/8G/10G, FICON, FICON Express, ESCON ● CPRI: 1.23/2.46/6, 14/9.83 Gbit/s, OTN:OTU2, OTU2V
Occupied Slot Number	Occupy 1 slot, applicable to the OTNs platform
WDM Technology	Support DWDM: C Band, 100GHz or 50GHz Support CWDM: 1270nm~1610nm
3R Technology	Support 3R function: Re-amplifying, Retiming, Re-shaping
Network Management Function	<ul style="list-style-type: none"> ● Support real time monitoring for port work state, including: transmitting optical power, receiving optical power, temperature, etc ● Support set for the work rate of ports ● Support port loopback and port shutdown
Interface	Support 8 pluggable optical port of SFP/ SFP+
Typical Power Consumption	20 W
MTBF	> 100000 hours

2.5G-OEO-4CHSFP: 4x2.5G Any Service Access Board

2.5G-OEO-4CHSFP is a 4-channel 2.5G service access card. Its main function is to finish the 3R regeneration of any 4-channel signals under any protocol within the rate of 42Mbit/s~2.67Gbit/s to be accessed, and then convert them to optical signals of a standard DWDM wavelength or standard CWDM wavelength, so that the multiplexing unit can conduct WDM for optical signals of different wavelengths and also achieve the inverse process of the above process. It's applicable to the low-cost wavelength division transmission solution for any access of services with the rate of 2.5G or below.

Product Diagram

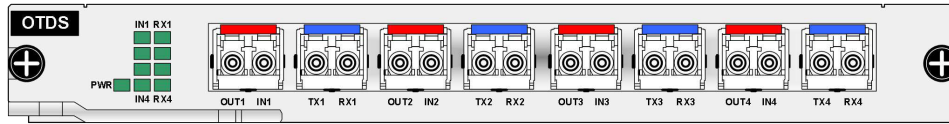

Functional Structure

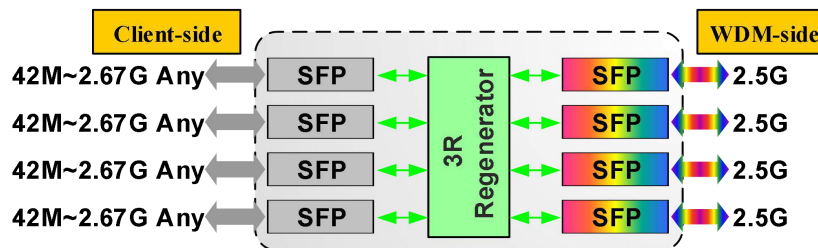

Product Specification

Product Model	2.5G-OEO-4CHSFP
Basic Function	<ul style="list-style-type: none"> Support bidirectional transmission of 4-channel services with any rate of 42Mbit/s~2.67Gbit/s Support unidirectional transmission of 8-channel services with any rate of 42Mbit/s~2.67Gbit/s
Access Service Type	<ul style="list-style-type: none"> FE, GE, STM-1/4/16/ FC 1G/2G, FICON, FICON Express, ESCON CPRI:614.4Mbit/s, 1.23/2.46Gbit/s
Occupied Slot Number	Occupy 1 slot, applicable to the platform of the OTNs
WDM Technology	Support DWDM: C Band, 100GHz or 50GHz Support CWDM: 1270nm~1610nm
3R Technology	Support 3R function: Re-amplifying, Retiming, Re-shaping
Network Management Function	<ul style="list-style-type: none"> Support real time monitoring for port working state, including: transmitting optical power, receiving optical power, temperature, etc Support the self adaptation of the working rate
Interface	It supports 8 pluggable optical port SFP, and the electrical interface SFP can be configured when the electrical interface service is accessed
Typical Power Consumption	15 W
MTBF	> 100000 hours

SOA: 100G Semiconductor Optical Amplifier Board

SOA is an O-band semiconductor optical amplification board. Its main function is to amplify the optical signal within the range of 1260~1360nm, with the maximum rate support of 160Gb/s. It has characteristics such as stable output power, low output noise and low polarization dependent gain. The single-board supports the access to 2-channel independent optical signals. It's suitable for the amplification for 40G or 100G small power signals in the construction of security system.

Product Diagram



Functional Structure

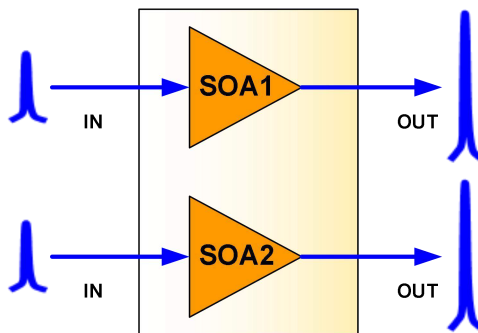

Product Specification

Parameter		Minimum Value	Normal Value	Maximum Value
Work Wavelength Range	40GE	1260nm		1340nm
	100GE	1290nm		1320nm
Input Optical Power Range		-20dBm		-10 dBm
Saturated Output Power			10 dBm	

Gain		14dB	
Noise		7.5 dB	
Polarization Dependent Gain			2dB
Occupied Slot Number	Occupy 1 slot, applicable to the platform of the OTNs		
Network Management Function	<ul style="list-style-type: none"> ● Support real-time monitoring of work state, including input optical power, output optical power, gain, temperature, etc ● Support adjustable APC gain ● Support adjustment of output optical power range and input optical power threshold 		
Optical Interface	All interfaces are LC type		
Typical Power Consumption	20 w		
MTBF	> 100000 hours		

EDFA: erbium-doped fiber amplifier board

EDFA is the erbium-doped fiber amplification board. Its main function is to compensate the power of the signal optical in the transmission line, and it can amplify the optical signals of up to 48 channels with 100 GHz's interval) or 96 channels with 50 GHz's interval) at C band at the same time. It has characters of flat gain, locked gain, low noise index, etc. It's an indispensable and important component for DWDM system, future high speed system and all-optical network long-distance transmission.

Product Diagram

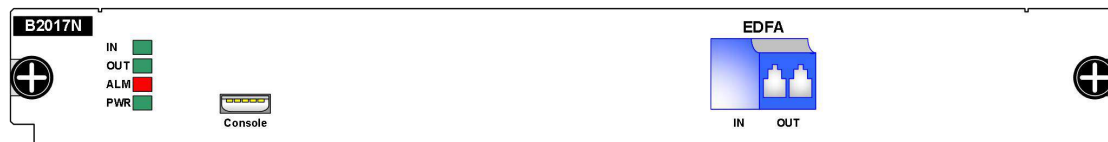

Functional Structure

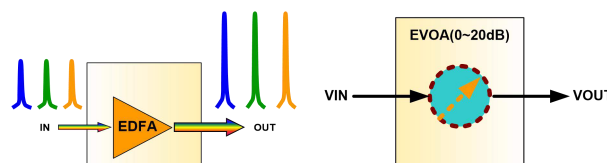

Product Specification

Work Wavelength Range	Standard type: 1528nm~1561nm, suitable for 40wavelength (100 GHZ) or 80 wavelength (50 GHZ) DWDM systems		
	Extension type: 1528nm~1568nm, suitable for 48 (100 GHZ) or 96 wavelength (50 GHZ) DWDM systems		
EDFA Type	BA (boost amplifier)	LA (line-amplifier)	PA (pre-amplifier)
Minimum Input Optical Power	-32 dBm	-32 dBm	-32 dBm
Maximum Output Optical Power	+20dBm	+20dBm	+17dBm
Maximum Gain	20dB	33dB	30dB
Noise Factor	< 5dB	< 5 dB	< 5 dB
Gain Flatness	< 1.5dB	< 1.5dB	< 1.5dB
Occupied Slot Number	Occupy 1 slot, suitable for the platform of the OTNs		
Network Management Function	Support real time monitoring for EDFA's work state, including: optical power, optical pumping, temperature, etc		
Unique Technology	Support gain locking technology, transient control technology automatic shut-off technology of output optical power		
EVOA	Built-in (optional); network management can adjust attenuation's dynamic range of 1.5 dB~21.5 dB		
Optical Interface	All interfaces are LC type		
Typical Power Consumption	15 w		
MTBF	> 100000 hours		

OLP: Optical Line Protection Board

OLP is an optical wavelength/line protection board. Its main function is to perform a real-time monitoring on the state of signals in the main and backup fiber. Once the fiber core is blocked or under degradation, it can switch automatically and safely between the main and backup fiber to guarantee prompt recovery of optical signals on the system line. OLP technology is to complete the routing switch operation at the optical layer. The optical layer protection has the incomparable advantages over the upper services protection, and it is the best solution to provide users with an uninterrupted communication.

Product Diagram

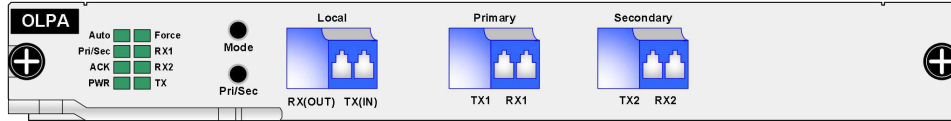

Functional Structure

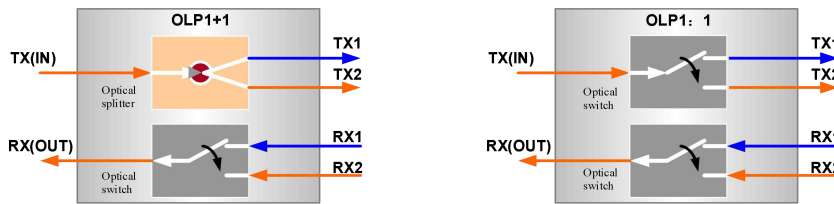

Product Specification

Product Model		OLPA(1+1)	OLPB(1:1)
Work wavelength range		1260nm~1650nm	
Occupied slot number		Occupy 1 slot, suitable for the platform of the OTNs	
Switch mechanism		Selectively receiving from double transmitting, and then single-end switches	Selectively receiving and transmitting, and then both-ends simultaneous switch
Switch time		< 20ms	< 40ms
Introduction loss	TX-TX1	< 3.5 db	< 0.8dB
	TX-TX2	< 3.5 db	< 0.8dB
	RX1-RX	< 0.8dB	< 0.8dB
	RX2-RX	< 0.8dB	< 0.8dB
Monitoring of optical power range		-50 dBm~+ 25 dBm	
Network management function		It supports the OLP optical power real-time monitoring, active switch scheduling, performance management, routing management, and other management functions	
Application scenes		Used for optical line 1+1 protection, optical wavelength 1+1 protection	
Optical interface		All interfaces are LC type	
Typical power consumption		5 w	
MTBF		> 100000 hours	

MDU: Multiplexer/de-multiplexer Board

MDU is multiplexer/de-multiplexer board based on WDM technology, and the multiplexer board is to combine multiple standard DWDM or CWDM wavelengths at the transmitting end and multiplex them on the same optical fiber for the transmission. The de-multiplexer board is to separate the multiple standard DWDM or CWDM wavelengths which are carried on the single fiber. They are used to transmit optical signals of different wavelengths on the same optical fiber at the same time, which greatly saves the clients' fiber resources. Flexible configuration can be set according to the client's demand, with the support of multiplexer/ de-multiplexer for up to 40 DWDM wavelengths.

Product Diagram

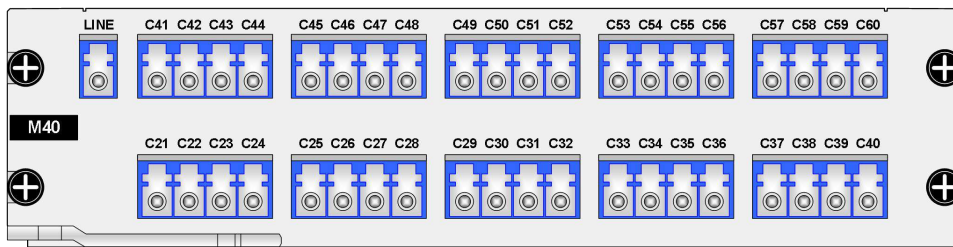

40 channels multiplexer board

Functional Structure

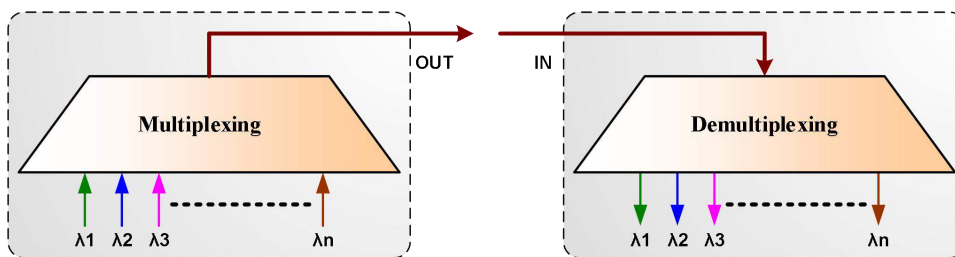

Product Specification

Commonly Used Channel Number	2x4	2x8	1x16	1x40
Occupied Slot Number	1	1	1	2
WDM Specifications	DWDM& CWDM	DWDM&C WDM	DWDM& CWDM	DWDM
Production Process	Filter	Filter	Filter	Array wave guide grating
Insertion Loss of Each Channel	< 1.5dB	< 2.5dB	< 3.5dB	< 5.5dB
Isolation Ratio of Adjacent Channels	> 30dB	> 30dB	> 30dB	> 25dB
Isolation Ratio of Non-adjacent Channels	> 40dB	> 40dB	> 40dB	> 30dB
Reflection Coefficient	< -45dB	< -45dB	< -45dB	< -40dB
Interface Type	All interfaces are LC types			
Typical Power Consumption	0 W (passive optical device)			
MTBF	> 200000 hours			

DCF: dispersion compensation board

DCF is the negative dispersion optical fiber, which is a new kind of single mode optical fiber designed for current G.652& G.655 standard single-mode optical fiber; the dispersion of G.652 optical fiber in the vicinity of 1550nm wavelength is positive (17-20) ps/nm (km), and the dispersion of G.655 standard optical fiber in the vicinity of 1550nm wavelength is positive (4-6) ps/nm (km), with a positive dispersion slope. So we need to add dispersion compensation fiber with negative dispersion into the optical fiber to carry out the dispersion compensation and make sure that the total dispersion of the whole optical fiber line is near zero. Thus high speed, large capacity and long distance communication can be realized.

Product Diagram

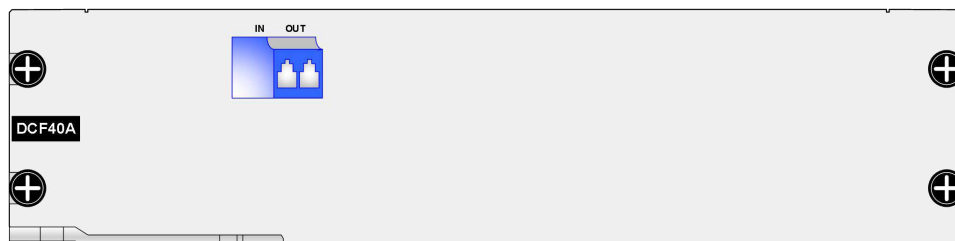

Dispersion Compensation Principle

Dispersion is one of the transmission properties of optical fiber, and the optical pulse signal will be broadened in time after transmission in the fiber for a distance, which produces inter-symbol interference, thus increasing the error rate and affecting the quality of communication.

- The higher the data rate is, more easily the inter-symbol interference will occur
- The longer the transmission distance is, more easily the inter-symbol interference will occur

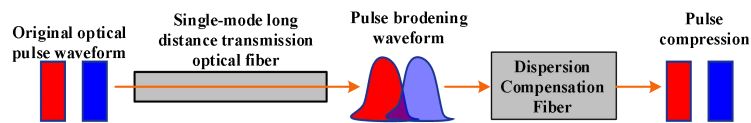

Product Specification

Product Model	DCM20A	DCM40A	DCM60A	DCM80A	DCM100A
Equivalent G.652 Compensation Distance	20km	40km	60km	80km	100km
1545nm Wavelength Dispersion(ps/nm)	-340±20	-670±30	-1000±40	-1340±50	-1670±60
1545nm Wavelength Relative Dispersion slope	0.004±20%(nm-1)				
Insertion Loss	≤3.6 dB	≤4.8 dB	≤6.8 dB	≤8.7 dB	≤9.7 dB
Polarization Mode Dispersion	≤0.6 ps	≤0.9 ps	≤1 ps	≤1 ps	≤1 ps
Nominal Single-wave Input Optical Power	≤0 dBm				
Optical Interface	All interfaces are LC type				
Typical Power Consumption	0W (passive components)				
MTBF	> 200000 hours				
Occupied Slot Number	2 slots (dispersion compensation board used for over 40km needs to be configured individually with DCF passive frame)				

OPNC: network management board

OPNC is a network management function module. It is specially designed for OTNs products. The main function is to provide interfaces for equipment and network management system. The module, together with the OTNs NMS network management system, completes management and maintenance of every board and transmission of management signal, and realizes the real-time monitoring, maintenance and management for equipment network elements and the whole synchronous equipment network. Thus it offers a good solution for equipment monitoring.

Product Diagram

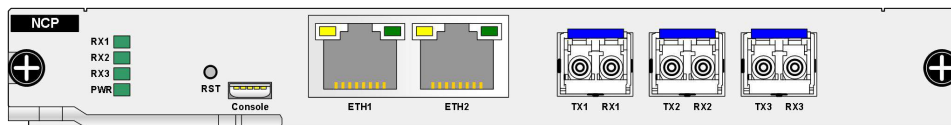

Product Features

- ❖ Adopt the high speed ARM processor, provide powerful data processing ability, collect state information, alarm events and performance parameters of all single-board functional modules to transform, process and store, and also transmit the control and management information to other functional modules of the equipment at the same time;
- ❖ Provide 1 Console interface, support simulation terminal operation;
- ❖ Provide 2 SNMP interfaces, support graphical SNMP support based on IP modes;
- ❖ Provide 3 SFP optical transceiver interfaces, support equipment in-band management, realize processing of 3 optical monitoring channels, complete the reception and transmission of optical monitoring signals from every station;
- ❖ Network management module supports hot plug. The normal working of the current service module will not be affected even it failures.

Product Specification

Product Model	OPNC
Occupied Slot Number	Occupy 1 slot, suitable for the OTNs platform
local Management Serial Port	Support a Micro-USB serial port of local management
Remote Management Ports	Support two RJ45 Ethernet ports, self adaptive to 10/100/1000M
OSC Optical Monitoring Port	Support three pluggable optical port SFP, with LC type interface
Network Management Way	Support a variety of network management ways of CLI, Telnet, SNMP, Web
Exchange Function	Support IP communication function between equipment, realize integrated management of several sets of equipment
Protection Function	Failure of hot plug network management card will not affect existing service
Maintenance Functions	Support online upgrade of local or remote software
Working Temperature	--10°C~+60°C
Working Humidity	5%~95%
Typical Power Consumption	5W
MTBF	> 100000 hours

NMS: network management system

NMS is a sub-network level integrated network management system for the optical transmission network, which can manage all the OTNs equipment in the unified management and provides standard external interface to be used by the upper network management at the same time, thus providing a complete solution for the transmission network management.

Basic Function

NMS provide all management functions for the network element layer (security management, topology management, alarm management, performance management, configuration management, system management).

Functional Structure

Currently, it uses C/S (Client/Server) structure, supports the distributing and layering of the database system, service processing system and foreground application system, supports multiple client operation and adopts the scalable modular architecture design which can be disassembled and reassembled and be able to adapt to the needs of complex and large network management.

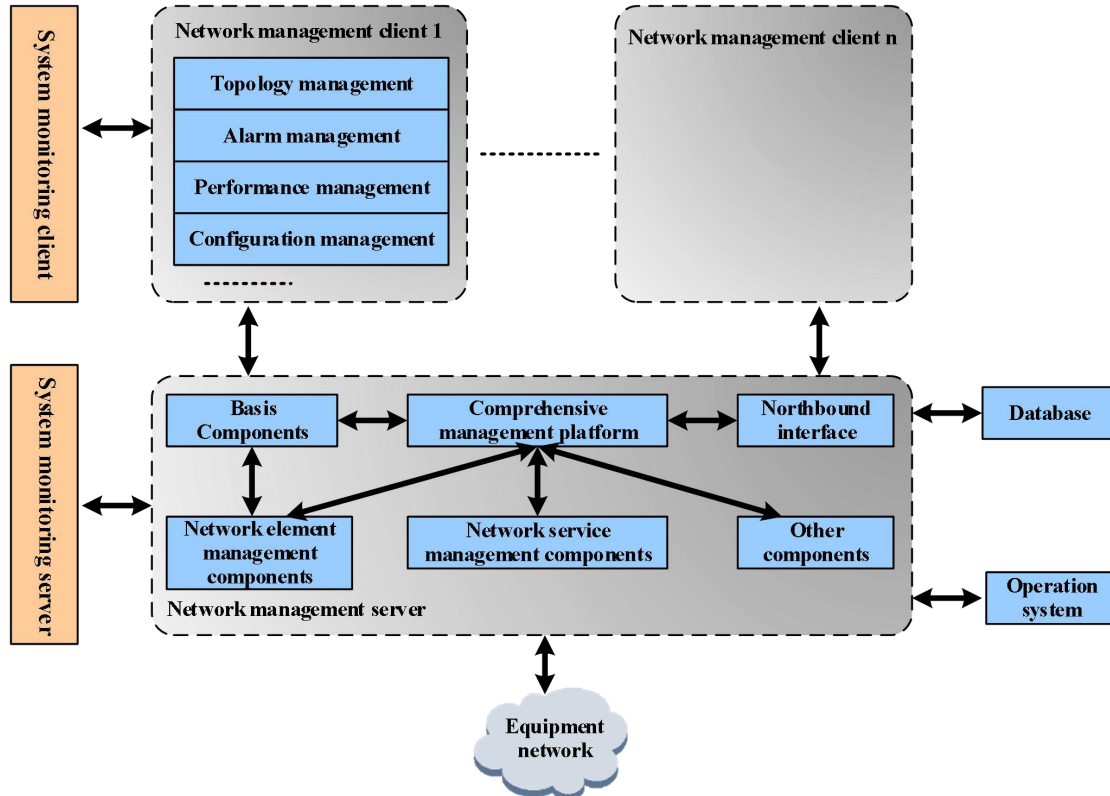

Network Management Diagram



WEB NMS SYSTEM

- Running
- Equipment General view
- Single Card List
- Alarm Management**
- Current Alarm
- History Alarm
- Alarm Policy Settings
- Network Management**
- IP Address Configuration
- SNMP Configuration**
- Safety Management**
- Equipment Maintenance
- Equipment Maintenance**
- System Information
- Remote Upgrade
- Running Log

Device Identifier :

Current location: Network Managment > SNMP Configuration

Global Configuration

SNMP status	Enable
ip address	
SNMP Read Com	public
SNMP Write Com	private

SNMP Trap configuration

Serial No.	Target host name	IP address	UDP communication port	Status	Modify	Delete
1	Host 238	192.168.1.238	9162	Enable	Edit	

Applications of WDM in Single Fiber Bidirectional Transmission

Scene Description

Due to the absence of their own optical fibers, the interconnection between government centers and enterprise parks mainly adopts the way of broadband renting currently. But as the growth of the broadband requirements, the demand of renting the bare fiber for self-built wavelength division load network have increased. In order to further save network construction costs, a new solution is proposed to construct large-capacity wavelength division based on the single fiber bidirectional technology.

Case study: the interconnection between government centers, single fiber bidirectional wavelength division transmission network

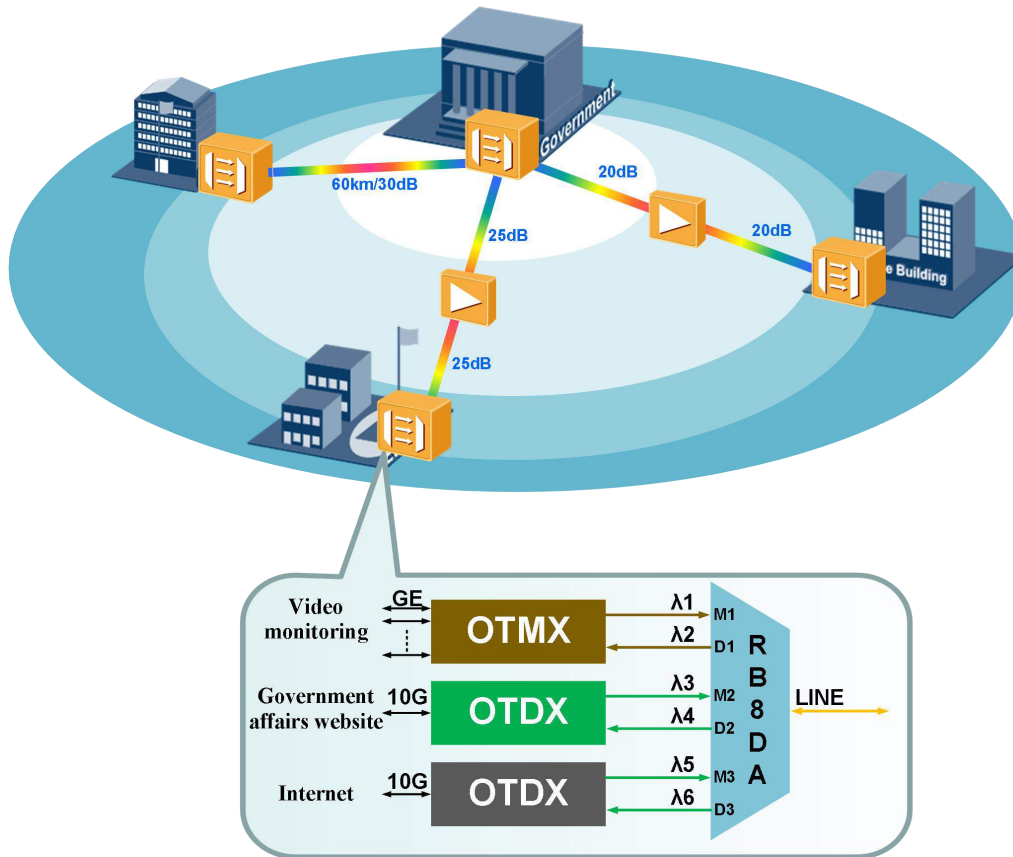

Highlights in the Solution

1. Single fiber system supports 10G transmission, which makes a good solution to the contradiction between optical fiber and broadband;
2. It supports 100M~10G full-service access;
3. Physical isolation between the services, and dedicated network for special purpose;
4. Metro fiber cable loss is generally high and the system can be configured with optical

- amplification to solve the problems of long distance transmission and fiber loss;
5. 1U equipment can meet the service requirements, because it's flexible, plug-and-play, free-of-configuration and maintenance free.

Applications of WDM Transmission Networks for Disaster Tolerance Backup

Scene Description

With the construction of the data center construction for private network clients from such as cloud network, IDC and big enterprises, the demand for the disaster tolerance backup system demand is increasing. Clients choose the self-built wavelength division method to solve the contradiction between the fiber and large broadband which not only can improve network reliability by "private network for special purpose" but also achieve high-broadband service transmission and even meet the flexible extension of long-term service.

Case study: wavelength division transmission network of enterprise disaster tolerance backup (1+1 hot standby)

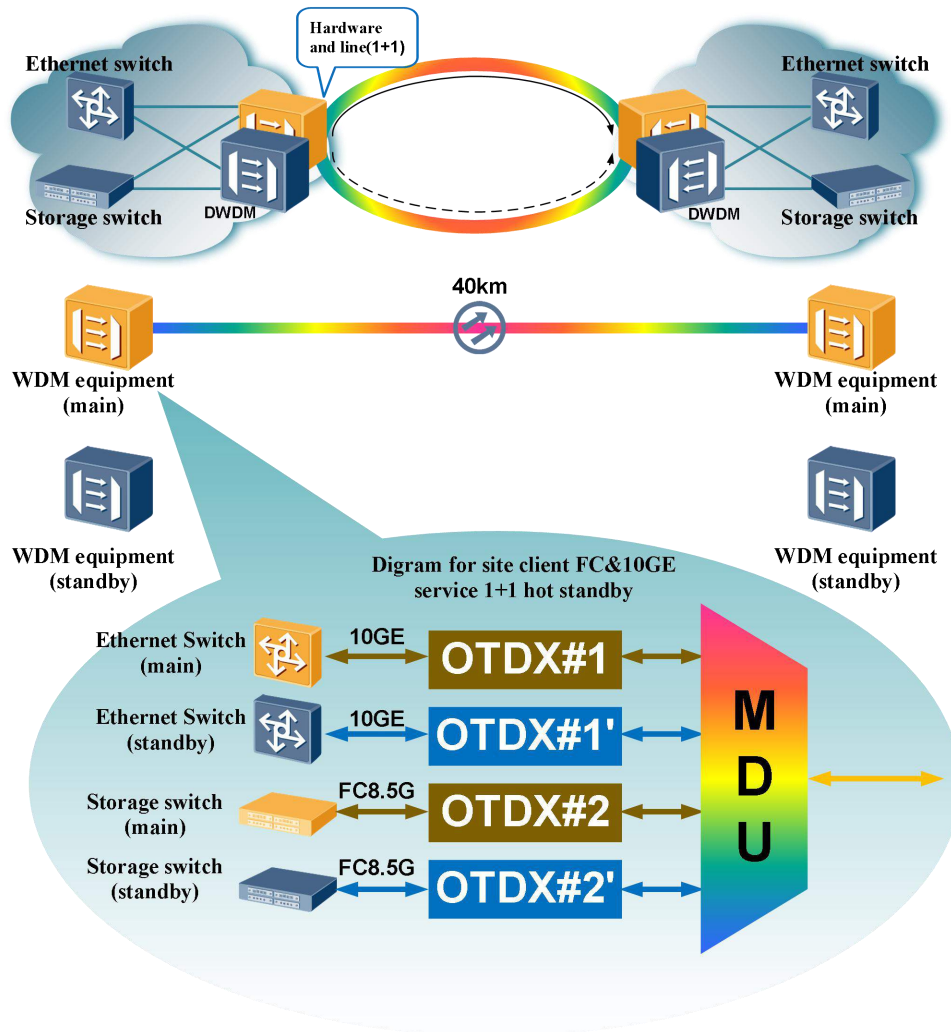

Highlights in the Solution

1. The most comprehensive IP and SAN service interface, which supports almost all of the IP and SAN services at present;
2. The scope of disaster backup expands to 130 km, meeting the demand of the large volume of disaster backup for multiple physical nodes;
3. 1+1 backup protection for wavelength division hardware and line achieves the highest network protection.

Applications of OTN Transmission Bandwidth Cloud Scene Description

With deepening of informatization in the industry, larger-particle Ethernet services have been gradually rising, which leads to the fast growth of the traffic in the access layer, metro area layer and backbone network. Therefore, the construction of the multiple service transmission platform and the provision of high capacity channel has become a new development direction for the transmission network technology. The solution of "OTN transmission broadband cloud" is just born for this. The "OTN transmission broadband Cloud" is a blend of advanced technology of 10G~100G and large capacity OTN photoelectric cross. Just like the "cloud computing", it has formed a large-capacity, dynamic shared, quickly accessible, intelligent and reliable network.

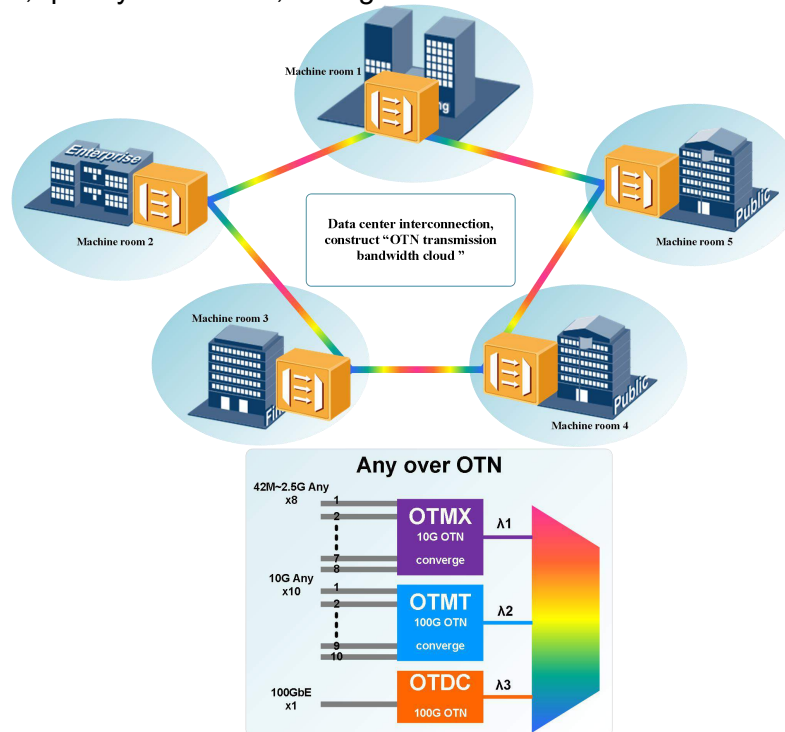

Highlights in the Solution:

1. Construct the large volume pipe with the 100G technology, and allow the entire network to share 100G broadband channel via OTN technology at the same time;
2. Meet the scheduling demand for large capacity and flexible network, support 40->80 wave or 10G->100G modular expansion, ensure the network to smoothly upgrade to 8T massive transfer, which not only saves the initial investment but also satisfies the future network development for many years;
3. OTN transmission broadband cloud solves the industry various clients' challenges in the industry planning, construction, maintenance and other aspects and brings the client a experience of "zero waste large broadband, rapid release and zero waiting, and zero service interruption"
4. Unified management, intelligent network management, real-time monitoring of network running status all guarantee the stability of the network.

Applications of WDM Unidirectional Transmission Network

Scene Description

Big data era is formally arriving with the development and popularity of the age of the Internet, the core of the construction of the cloud services based on large data is to conduct data collection and analysis in order to show the value of the data. Because of the network various sources and huge amount of the data, the large-scale network data analysis platform is usually established in equipment room in non-local locations. The WDM unidirectional transmission solution can provide real-time, reliable, safe and stable data transmission for non-local network data analysis platform.

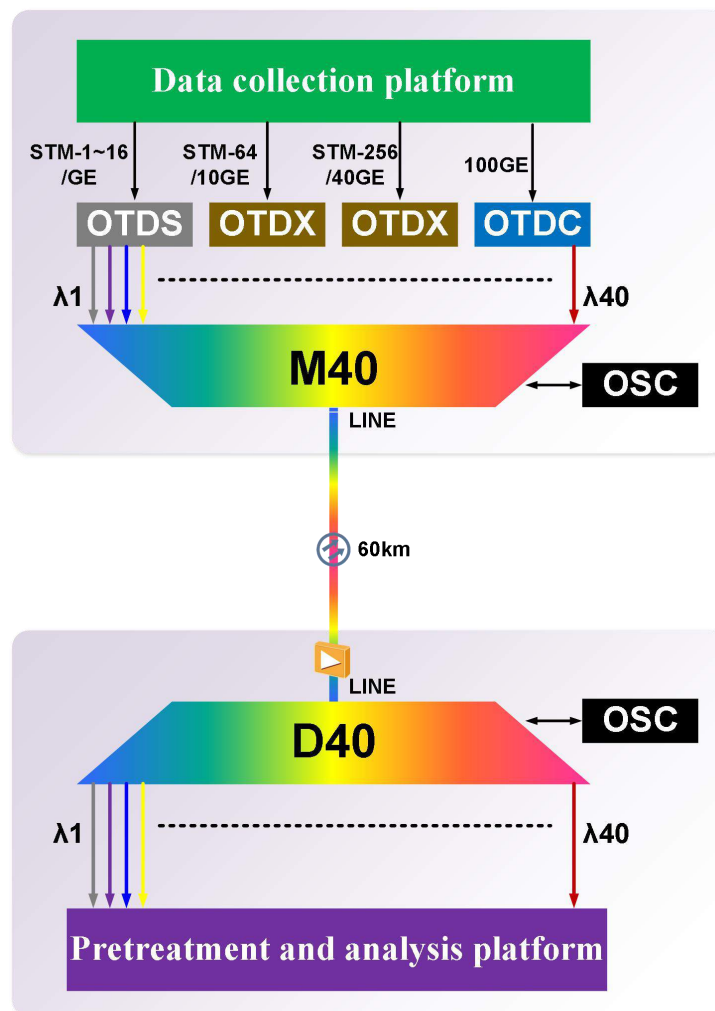

Highlights in the Solution:

1. It supports 100M~100G full-service access, all types of services can access system, and they are all transmitted on a single fiber by multiplexing;
2. It supports the transmission upon the expansion from 40 wavelength to 80 wavelength

- or the convergence from 10G to 100G, which maximizes the use of fiber core and channel resources;
3. Network transmission signals and service signals are jointly transmitted to the pretreatment equipment room, so as to realize a unified network for the entire network equipment.

Applications of Optical Amplification

Scene Description

With the development of the network security technology, currently, in many key links of the optical fiber network, there will be many security systems which require the traffic on this link; the image and copy for the optical data links in the industry basically adopts the optical splitting approach as a solution, so as to ensure the reasonable traffic collection under the condition of not affecting the original link transmission. The copying link which has gone through the optical splitting approach can amplify the signal with the optical amplifier, so as to guarantee to provide more high quality data flow for the security management platform. The FM-1400mplification platform has characteristics of compact structure, flexible configuration and low power consumption and it supports the optical amplification for full modes of 100M~100G as well as for full rates, which are widely applied to the fields of operators, private networks and information.

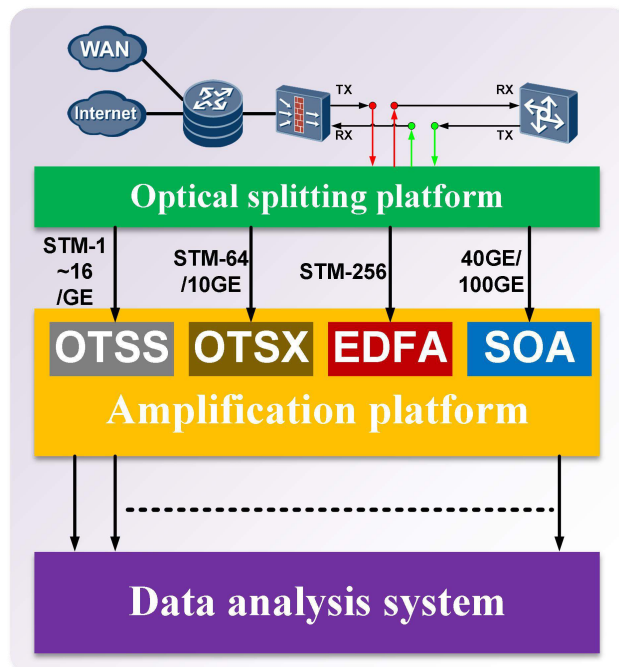

Highlights in the Solution:

1. It supports optical amplification for SDH/SONET services at various rate levels and services such as POS, GE, 10 GE, 40 GE and 100 GE, which can be adaptive to any scene.

- High level of integration: 1U platform can support the amplification for 155M~10G signals of up to 16 links (including a total of 32 channels uplink and downlink) or the amplification for 100G signals of up to 4 links (including a total of 8 channels uplink and downlink).

2U platform can support the amplification for 155M~10G signals of up to 32 links (including a total of 64 channels uplink and downlink) or the amplification for 100G signals of up to 8 links (including a total of 16 channels uplink and downlink).

5U platform can support the amplification for 155M~10G signals of up to 72 links (including a total of 144 channels uplink and downlink) or the amplification for 100G signals of up to 18 links (including a total of 36 channels uplink and downlink).

OLP line Protection Applications

Scene Description

Optical line protection (OLP) technology is a kind of simple, flexible, economic and practical means of protection, which can effectively decrease the times of interruption of optical transmission system and has had a large number of applications in the first- and second-level DWDM transmission systems.

1+1 protection way:

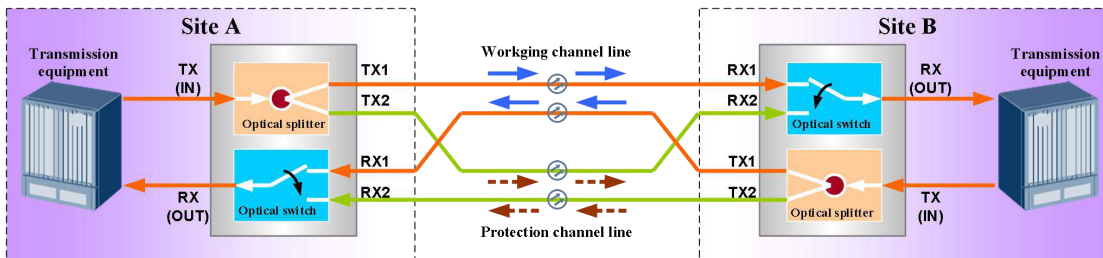

It's a hot standby mechanism of double transmitter or receiver and single-end rearrangement where OLP transmitter will split the signal into two parts at the same time to transmit them to the optical fiber of working and protection line, the OLP receiver inspects and compares the optical power of the signals in the working and protection line and then select the superior signal from one of two channels through optical switch.

1:1 protection way:

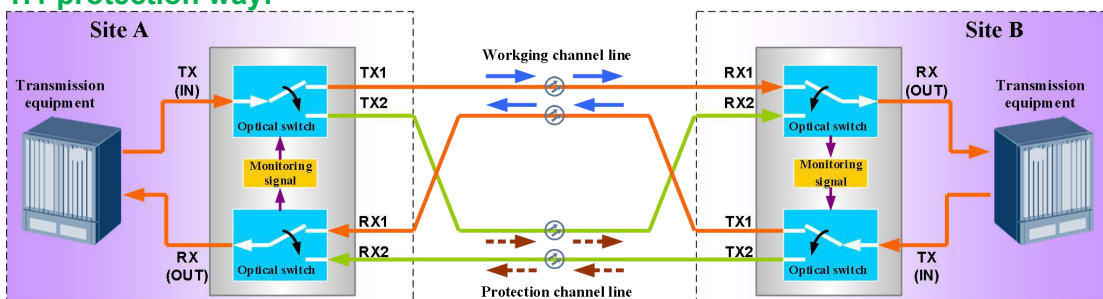

The OLP transmitting end and receiving end are linkage optical switches. During normal working, the switch selects the line of the service channel for the optical signal transmission, and the line of protection line is used for the monitoring of signal communication for OLP on both ends. During the rearrangement, automatic optical switch at the home end and remote end conducts an automatic negotiation and implements switch through protection channel line.

Highlights in the Solution:

1. **Applicable to arbitrary scene:** used for all kinds of optical communication system and transparent transmission, having nothing to do with the line data, format and multiplex;
2. **Safe and reliable:** OLP adopts the design of the advanced optical switch and high-quality passive splitter, with a high reliability; and it is independent from network management board, without affecting each other;
3. **Automatic switch function:** automatically switch to the protection line when the optical fiber in the working channel line is blocked, so as to ensure no blocking for communication services;
4. **Monitoring features for line insertion loss:** conduct a real-time monitoring on the status of line insertion loss in the non-working optical channels and send out alarm prompt according to established alarm threshold, so as to ensure the validity and reliability of the protection system;
5. **Function of keep running for the power off and on:** no matter the OLP power is off or on, it does not affect the switch state of the main and standby routing and guarantees the normal working of the system; and it also has the hot plug function;
6. **Network management function:** support various management methods such as SNMP, CLI, Telnet and Web, implement the real-time monitoring, configuration and management on the OLP equipment state and the routing line status;
7. **Fast response:** Switching time of 1+1 protection <20ms, Switching time of 1:1 protection <40ms;
8. **Unified platform architecture:** OLP can work with our EDFA optical amplification and DCF dispersion compensation in the same chassis, and provide a one-stop solution for the protection and transformation of the DWDM network.

Single fiber unidirectional passive WDM board

The single fiber unidirectional passive wavelength division board has two function modules. Multiplexer board: it supports the multiplexing of multi-channel optical signals of WDM standard wavelength into one-core optical fiber for unidirectional transmission. De-multiplexer board: it divides the mixed optical signals transmitted by multiplexing board at the opposite end into the original multi-channel optical signals of WDM standard wavelength. By configuring 2 pairs of unidirectional wavelength division boards, it can expand the bidirectional transmission channel number to as many as 48 on two-core optical fibers.

Product Diagram

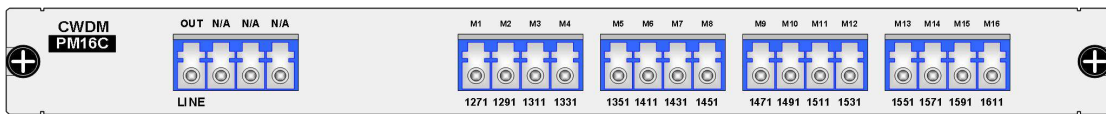

16 channels single fiber unidirectional passive multiplexer board

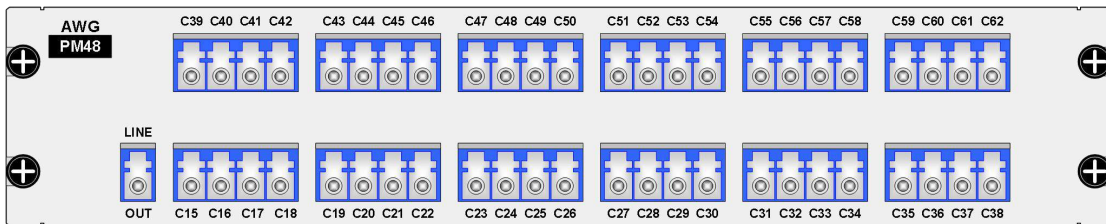

48 channels single fiber unidirectional passive multiplexer board

Functional Structure

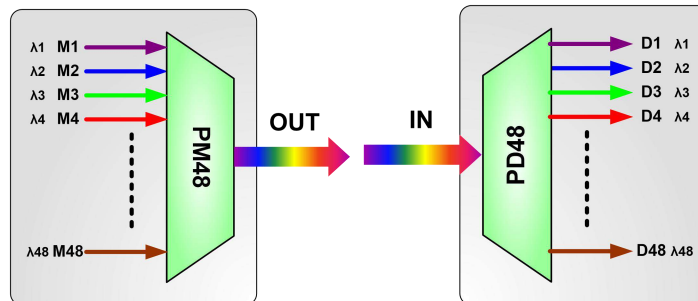

Product Specification

Number of Channels	8	16	40	48
Occupied Slot Number	1	1	2	2
Wavelength Range	CWDM:1270nm to 1610nm DWDM:C Band, 100 GHZ or 50 GHZ			
Insertion Loss	< 2.5 dB	< 3.5 dB	< 5.5 dB	< 5.5 dB
Isolation Ratio of Adjacent Channels	> 30 dB	> 30 dB	> 25 dB	> 25 dB
Isolation Ratio of Non-adjacent Channels	> 40 dB	> 40 dB	> 30 dB	> 30 dB
Return Loss	> 45 dB	> 45 dB	> 40 dB	> 40 dB
Direction	> 50 dB	> 50 dB	> 45 dB	> 45 dB
Interface Type	All interfaces are LC type			
Work Temperature	-40~85°C			
Storage Temperature	-40~85°C			

Dual fiber bidirectional passive WDM board

The dual fiber bidirectional passive wavelength division board has two built-in modules on one single board: wavelength division multiplexer and de-multiplexer. The board can expand the number of bidirectional transmission channels to 16 on the dual optical fibers, which supports multiple specifications of both CWDM and DWDM.

Product Diagram

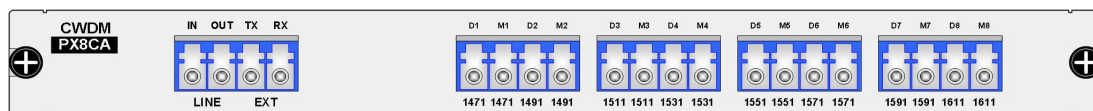

8 channels dual fiber bidirectional multiplexer/de-multiplexer board

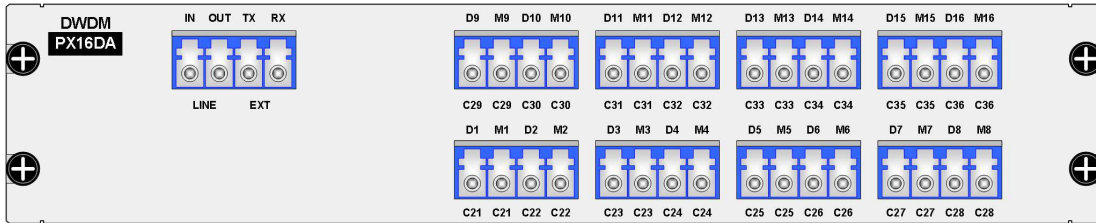

16 channels dual fiber bidirectional multiplexer/de-multiplexer board

Functional Structure

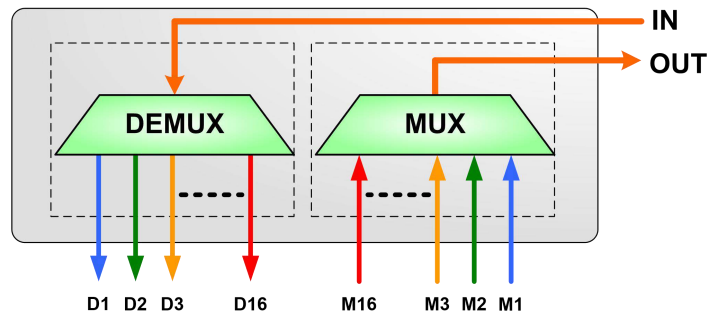

Product Specification

Number of Channels	4	8	16
Occupied Slot Number	1	1	2
Wavelength Range	CWDM:1270nm to 1610nm DWDM:C Band, 100 GHZ or 50 GHZ		
Insertion Loss	< 1.5 dB	< 2.5 dB	< 3.5 dB
Isolation Ratio of Adjacent Channels	> 30dB	> 30dB	> 30dB
Isolation Ratio of Non-adjacent Channels	> 40 dB	> 40 dB	> 40 dB
Return Loss	> 45dB	> 45dB	> 45dB
Direction	> 50dB	> 50dB	> 50dB
Interface Type	All interfaces are LC type		
Work Temperature	-40~85°C		
Storage Temperature	-40~85°C		

Single fiber bidirectional passive WDM board

The single fiber bidirectional passive wavelength division board adopts the feature that laser receiver is not sensitive to the wavelength. It can receive and transmit different and intertwined wavelengths on one-core fiber to achieve the service's bidirectional transmission. Two passive wavelength division boards need to be used in pairs; the single-board can expand the bidirectional transmission channel numbers to as many as 8 (CWDM) or 20 (DWDM) on one-core optical fiber.

Product Diagram

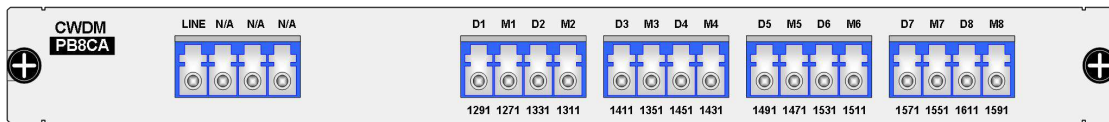

8 channels single fiber bidirectional multiplexer/de-multiplexer board

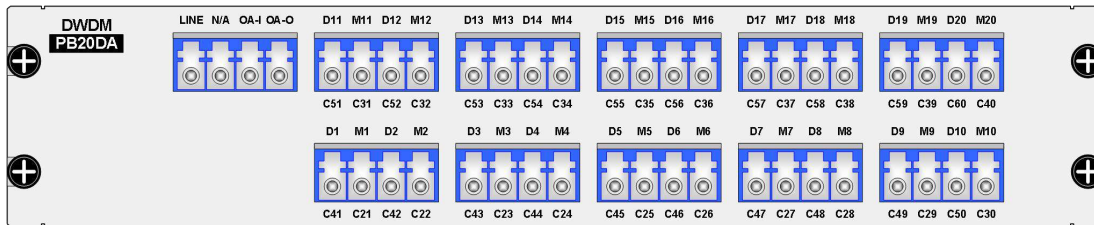

20 channels single fiber bidirectional multiplexer/de-multiplexer board

Functional Structure

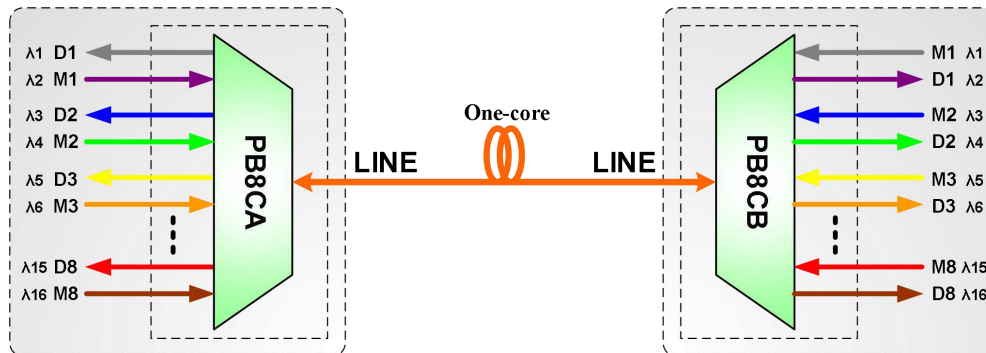

Product Specification

Number of Channels	4	8	20
Occupied Slot Number	1	1	2
Wavelength Range	CWDM:1270nm to 1610nm DWDM:C Band, 100 GHZ or 50 GHZ		
Insertion Loss	< 2.5 dB	< 3.5 dB	< 5.5 dB
Isolation Ratio of Adjacent Channels	> 30 dB	> 30 dB	> 30 dB
Isolation Ratio of Non-adjacent Channels	> 40 dB	> 40 dB	> 40 dB
Return Loss	> 45 dB	> 45 dB	> 45 dB
Direction	> 50 dB	> 50 dB	> 50 dB
Interface Type	All interfaces are LC type		
Work Temperature	-40~85°C		
Storage Temperature	-40~85°C		

Add-drop multiplexing passive WDM board

The add-drop multiplexing passive wavelength division board is generally used in the intermediate nodes of chain or ring type network, which can selectively receive and transmit or upload and download some wavelength division channels from the transmission signal without affecting the transmission of other channels. The single-board supports up to 8 channels' add-drop separately on two different directions.

Product Diagram



2 channels OADM board (single fiber bidirectional)

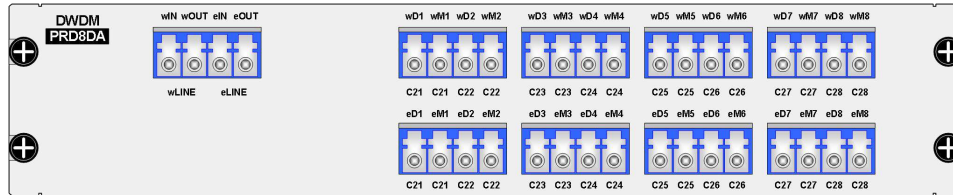

8 channels OADM board (dual fiber bidirectional)

Functional Structure

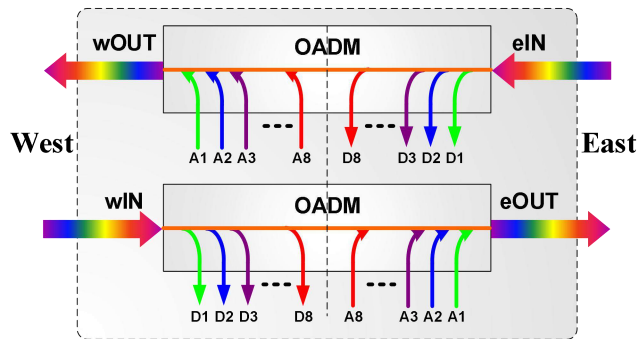

Product Specification

Number of Channels	1	2	4	8
Occupied Slot Number	1	1	1	2
Wavelength Range	CWDM:1270nm to 1610nm DWDM:C Band, 100 GHZ or 50 GHZ			
Insertion Loss	< 1 dB	< 1.5 dB	< 2.5 dB	< 3.5 dB
Isolation Ratio of Adjacent Channels	> 30 dB	> 30 dB	> 30 dB	> 30 dB
Isolation Ratio of Non-adjacent Channels	> 40 dB	> 40 dB	> 40 dB	> 40 dB
Return Loss	> 45 dB	> 45 dB	> 45 dB	> 45 dB
Direction	> 50 dB	> 50 dB	> 50 dB	> 50 dB
Interface Type	All interfaces are LC type			
Work Temperature	-40~85°C			
Storage Temperature	-40~85°C			